

VENICE™











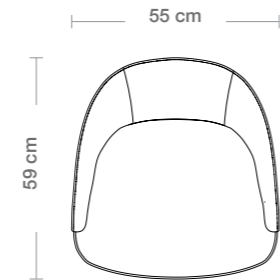
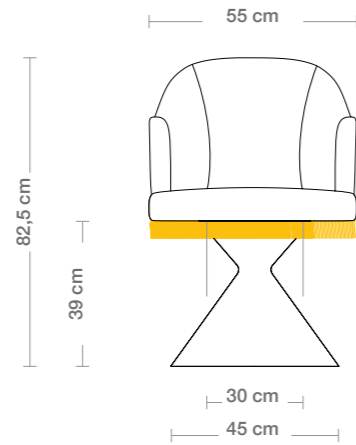
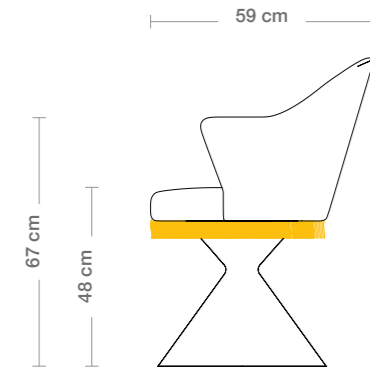

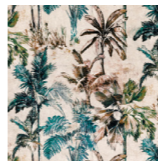



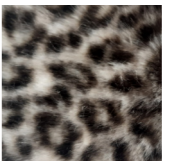

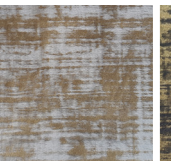
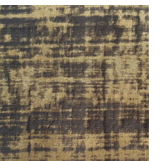

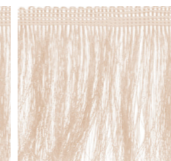
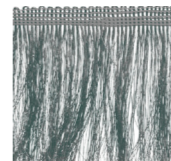

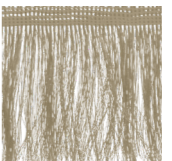
Designer Giovanni Pagani

Caratteristiche del prodotto

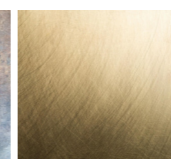
Seat with enveloping backrest and fringes. The wooden shell is covered in differentiated density polyurethane foam and finished with an upper layer of acrylic fibre. The upholstery is available in different colors and materials.

The hourglass base, available in various finishes, is made of steel.

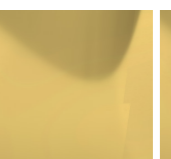

	LORELEI		LOLA	ROXANNE	ANGIE	VALERIE	JULIA	
Texture								
	Japura Velvet Amazonite	Japura Velvet Quartz	Ardecora Mito 257	This Must Be The Place 003	Husky-Snow Leopard	Mongolia Fur Two-tone Shade White/Blue	Venir Zafferano	Venir Nero
Fringe								
	Panna	Panna	Verdone	Panna	Somalia		Panna	Forsithia
Base								
	Mother-of-pearl Grey	Brushed Brass	Glossy Gold	Glossy Steel	Glossy Gold	Glossy Gold	Glossy Gold	Glossy Gold